

Examcollection

<http://www.ipass4sure.com/examcollection.htm>



<http://www.ipass4sure.com>

70-100

Microsoft

Analyzing Requirements and Defining Microsoft SOLUTION Architecture.

<http://www.ipass4sure.com/exams.asp?examcode=70-100>

Thousands of IT Professionals before you have already passed their 70-100 certification exams using the Microsoft 70-100 Practice Exam from ipass4sure.com. Once you start using our 70-100 exam questions you simply can't stop! You are guaranteed to pass your Microsoft 70-100 test with ease and in your first attempt.

Here's what you can expect from the ipass4sure Microsoft 70-100 course:

- * Up-to-Date Microsoft 70-100 questions designed to familiarize you with the real exam.
- * 100% correct Microsoft 70-100 answers you simply can't find in other 70-100 courses.
- * All of our tests are easy to download. Your file will be saved as a 70-100 PDF.
- * Microsoft 70-100 brain dump free content featuring the real 70-100 test questions.

Microsoft 70-100 Certification Exam is of core importance both in your Professional life and Microsoft Certification Path. With Microsoft Certification you can get a good job easily in the market and get on your path for success. Professionals who passed Microsoft 70-100 Certification Exam are an absolute favorite in the industry. If you pass Microsoft 70-100 Certification Exam then career opportunities are open for you.

Our 70-100 Questions & Answers provide you an easy solution to your Microsoft 70-100 Exam Preparation. Our 70-100 Q&As contains the most updated Microsoft 70-100 real tests. You can use our 70-100 Q&As on any PC with most versions of Acrobat Reader and prepare the exam easily.

DEMO EXAM

For Full Version visit

<http://www.ipass4sure.com/allexams.asp>

Total Scenarios # 7.

Missing explanations will be provided in next update.

Scenario: 1

ENCHANTMENT LAKES CORPORATION'S TRAVELER DATABASE

Background:

Line of Business:

Enchantment Lakes Corporation provides a variety of corporate travel services. These include booking services for individual travelers, management of corporate meetings, and management of travel expenses.

This Project:

The company wants to consolidate information about reservation and invoicing into a Traveler database, in order to provide consolidated reports. Reservation information must be collected from three different computerized reservation systems (CRSs). Invoice information is stored in an accounting system that is named Travel Data System (TDS), which runs on a Unix-based minicomputer. Information must be collected from each CRS and from TDS, checked for completeness and accuracy, and consolidated in the Traveler database.

Current Business Process:

VP Sales

We need to provide reports that succinctly summarize important data. Data accuracy and completeness are of utmost importance.

Chief Information Officer (CIO):

When a traveler makes a reservation, a travel agent enters details into the CRS. A reservation typically includes two flights, outbound and return, and each flight includes at least one segment. When a traveler changes reservations, a travel agent updates the reservation in the CRS, issues a new ticket. Many customers want specific information stored with each reservation. For example, a consulting firm might want a project number associated with each flight segment.

A CRS provides complete access to data about individual reservations, but does not support queries across reservations. For example, we cannot query a CRS to get total spending by customer for flights from New York to London in the past three months.

Customer Travel Director:

Often somebody will book a trip and receive the tickets, but cancel the trip at the last minute. The tickets need to be refunded or exchanged, but they just end up in a file folder somewhere.

Current Environment:

Chief Information Officer (CIO):

The CRSs do not maintain historical data. 24 hours after a traveler's last flight,, all information about the reservation is discarded. Each CRS uses a different coding scheme to identify airlines, airports, hotels, and car rental agencies.

Database Administrator:

The company has implemented an enterprise database that runs on Microsoft SQL Server. All company applications use the same tables for common data customers, airlines, hotels, car rental agencies, airport locations, etc.

Director of Application Development:

Travel agents are rather inconsistent about entering reservation data. They often omit important items, or put terms into a comment field in the CRS. Because the data in TDS originates from entries that were made in the CRS, the TDS data will reflect those same inaccuracies.

Proposed System:

Director of Application Development:

We need a system that will:

- 1- Capture data from each CRS and from TDS.
- 2- Transform the data to a standard data model.
- 3- Validate the data for completeness and accuracy.
- 4- Load the validated data into a Microsoft SQL Server database.
- 5- Match invoices to reservations.
- 6- Generate reports.

For each CRS, we will build a data collector application that will extract reservation data from the CRS and load it into a traveler-centered staging database. We will build another data collector application that will extract invoice data from TDS and load it into the same staging database.

A validation engine will read data from the staging database and check for accuracy and completeness. The validation engine will also translate CRS-specific codes for airlines, airports, hotels and car rental agencies to database keys from our Traveler database. Transactions and validations will be based on rules that are read from a rules database. Validation rules vary by customer and change frequently. We will need a rule editor.

The validation engine will pass invalid data to an exception handler. The exception handler will route invalid CRS data back to travel agent for correction at the host CRS. The exception handler will also route invalid TDS data to an accounting manager for correction in TDS. The validation engine will pass validated data to a data loader. The data loader will merge validated data into the Traveler database, matching invoices to reservations. Only validated data will be loaded into the Traveler database. Reports will be generated from data in the Traveler database.

Question Enchantment Lakes Corporation's Traveler Database

QUESTION 1. Draw a data flow from the CRS/TDS to the generation of month end reports, including validation and exceptions.

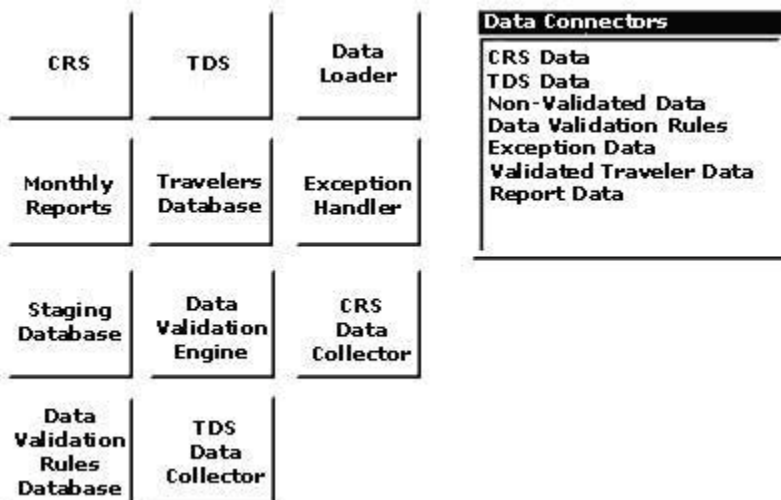

Answer:

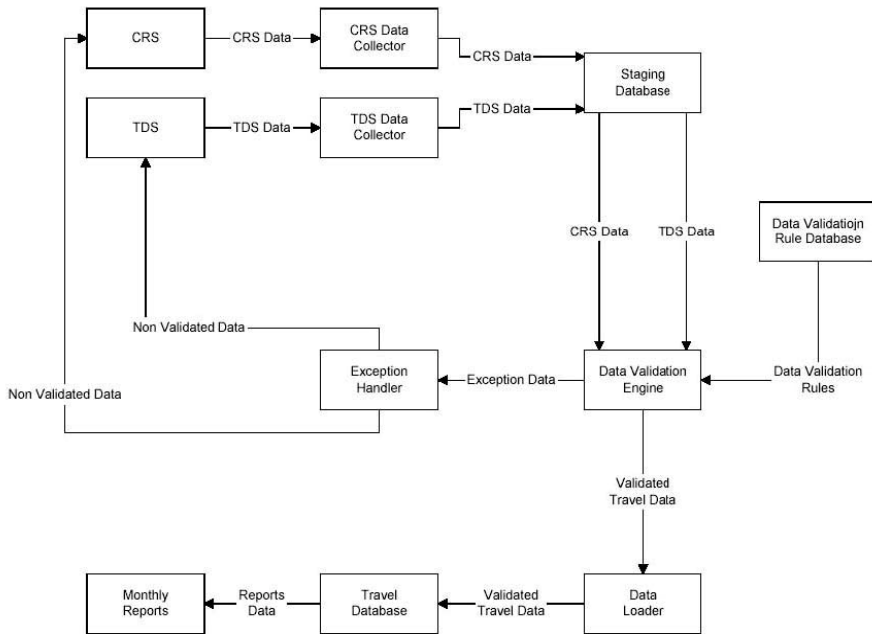

QUESTION 2. Draw a data flow from the CRS/TDS to the staging database.

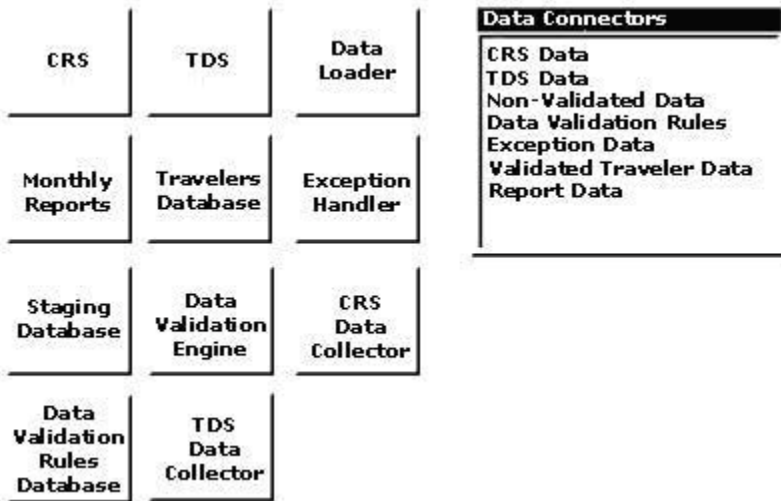

Answer:

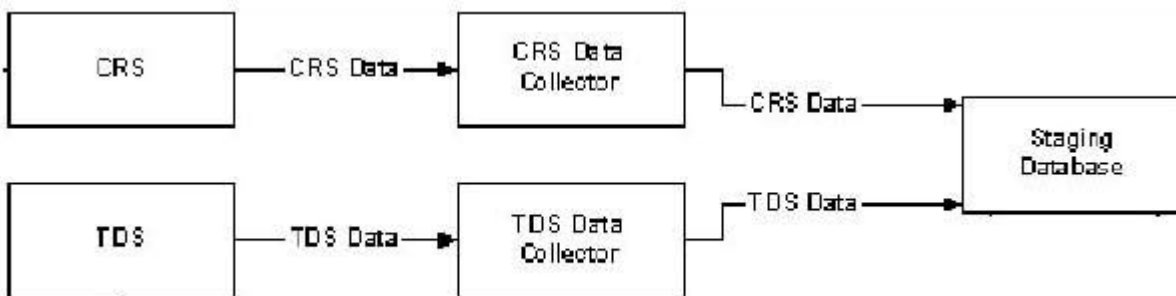

QUESTION 3. Split business rules into the three categories.

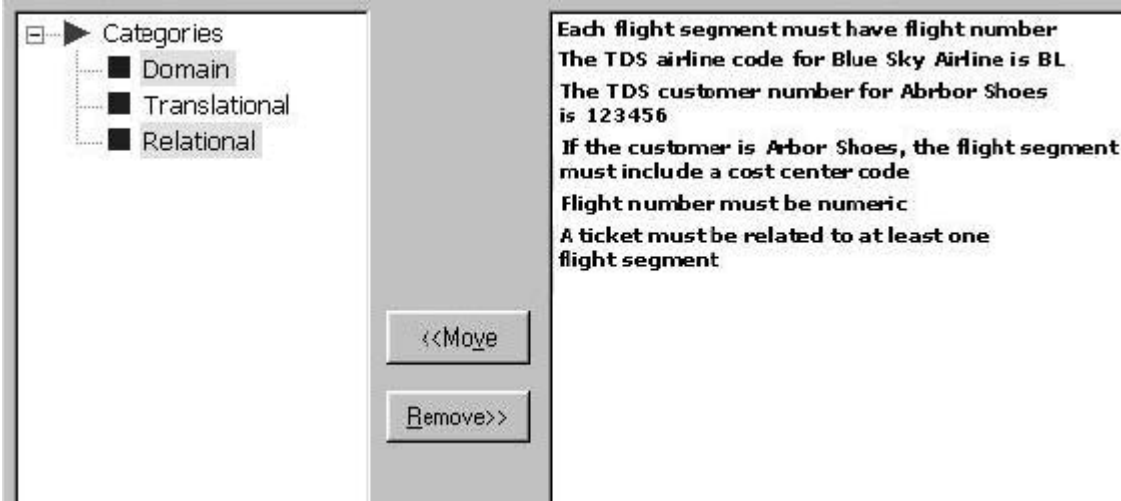

Answer:

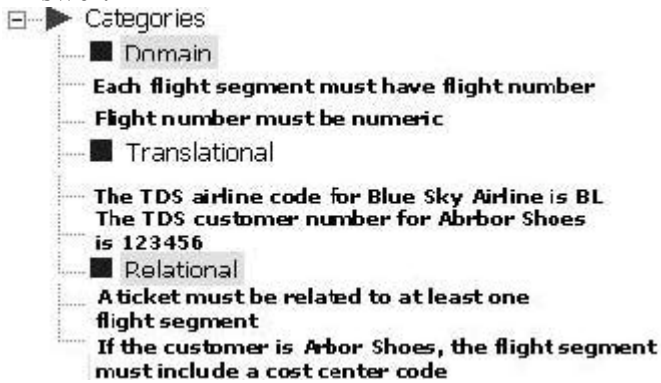

QUESTION 4. Draw a data flow from the staging database to the generation of month end reports, including validation and exceptions.

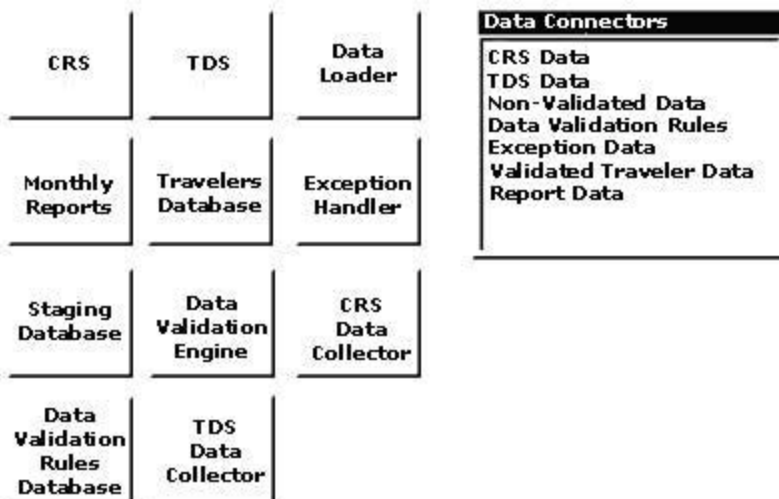

SAMPLE EXAM



Pass4sure \$89 Lifetime Membership Features;

- Pass4sure \$89 Lifetime Membership includes Over **2500** Exams in One Price.
- **All** Pass4sure **Questions and Answers** are included in \$89 package.
- **All** Pass4sure audio exams are included **free** in package (See List).
- **All** Pass4sure study guides are included **free** in package (See List).
- **Lifetime** login access, no hidden fee, no login expiry.
- **Free updates** for Lifetime.
- **Free Download Access** to All new exams added in future.
- Accurate answers with **explanations** (If applicable).
- **Verified answers** researched by industry experts.
- Study Material **updated** on regular basis.
- Questions, Answers and Study Guides are downloadable in **PDF** format.
- Audio Exams are downloadable in **MP3** format.
- **No authorization** code required to open exam.
- **Portable** anywhere.
- 100% success **Guarantee**.
- **Fast**, helpful support **24x7**.



View list of All exams (Q&A) provided in \$89 membership;

<http://www.ipass4sure.com/allexams.asp>

View list of All Study Guides (SG) provided FREE for members;

<http://www.ipass4sure.com/study-guides.asp>

View list of All Audio Exams (AE) provided FREE for members;

<http://www.ipass4sure.com/audio-exams.asp>

Download All Exams Sample QAs.

<http://www.ipass4sure.com/samples.asp>

To purchase \$89 Lifetime Full Access Membership click here (One time fee)

<https://www.regnow.com/softsell/nph-softsell.cgi?item=30820-3>

3COM	CompTIA	Filemaker	IBM	LPI	OMG	Sun
ADOBE	ComputerAssociates	Fortinet	IISFA	McAfee	Oracle	Sybase
APC	CWNP	Foundry	Intel	McData	PMI	Symantec
Apple	DELL	Fujitsu	ISACA	Microsoft	Polycom	TeraData
BEA	ECCouncil	GuidanceSoftware	ISC2	Mile2	RedHat	TIA
BICSI	EMC	HDI	ISEB	NetworkAppliance	Sair	Tibco
CheckPoint	Enterasys	Hitachi	ISM	Network-General	SASInstitute	TruSecure
Cisco	ExamExpress	HP	Juniper	Nokia	SCP	Veritas
Citrix	Exin	Huawei	Legato	Nortel	See-Beyond	Vmware
CIW	ExtremeNetworks	Hyperion	Lotus	Novell	SNIA	

and many others.. See complete list [Here](#)

